

1.000 PUBLIC ACCESS AREAS

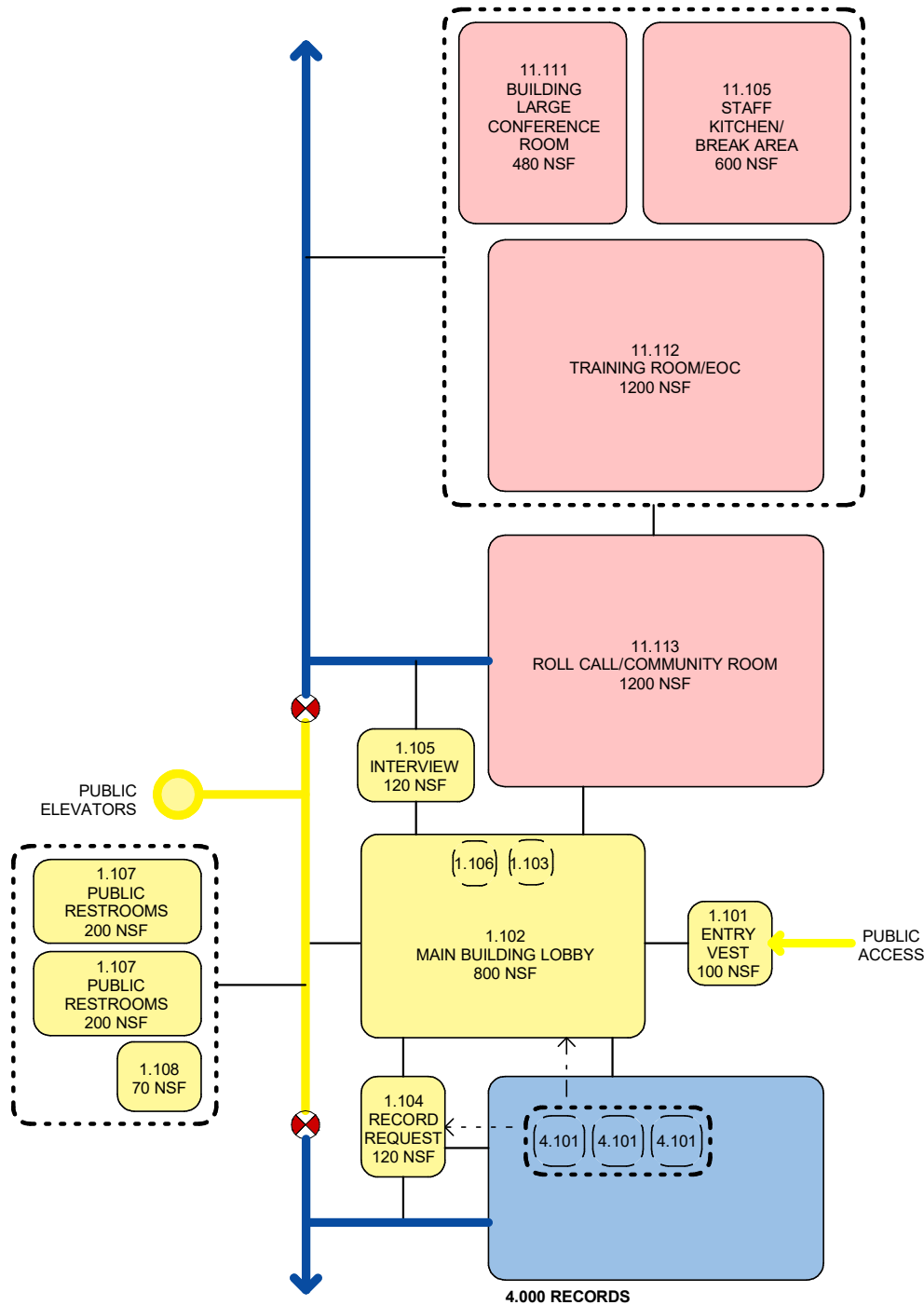

DIAGRAM LEGEND

- PRIMARY RELATIONSHIP
- ← - - VISUAL ADJACENCY
- PUBLIC CIRCULATION
- RESTRICTED CIRCULATION
- SECURE CIRCULATION
- ⊗ SECURE ACCESS POINT
- ⋯ REQUIRES IMMEDIATE PROXIMITY
- ▭ ENCLOSED SPACE/ AREA
- ▭ SPACE/ AREA IN OPEN SPACE

COLOR LEGEND

- ▭ 1.000 PUBLIC SPACES
- ▭ 2.000 ADMINISTRATION
- ▭ 3.000 ADMINISTRATIVE SERVICES
- ▭ 4.000 RECORDS
- ▭ 5.000 EVIDENCE & PROPERTY
- ▭ 6.000 COMMUNICATIONS
- ▭ 7.000 INVESTIGATION DIVISION
- ▭ 8.000 POLICE IT
- ▭ 9.000 COMMUNITY POLICING
- ▭ 10.000 JAIL - BOOKING & HOLDING
- ▭ 11.000 POLICE SHARED STAFF AREAS
- ▭ 12.000 TRAINING - FIRING RANGE
- ▭ 13.000 FACILITY SUPPORT AREAS
- ▭ 14.000 SPECIAL WEAPONS & TACTICS (SWAT/ HNT)

2.000 ADMINISTRATION

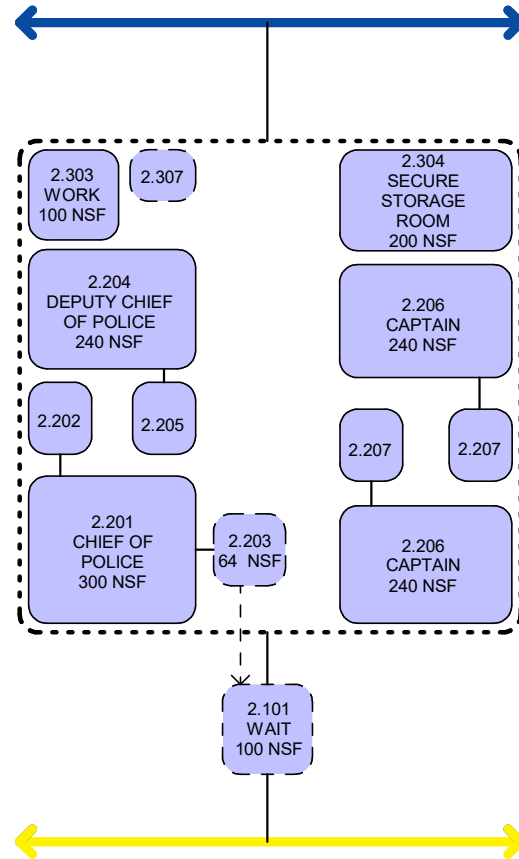
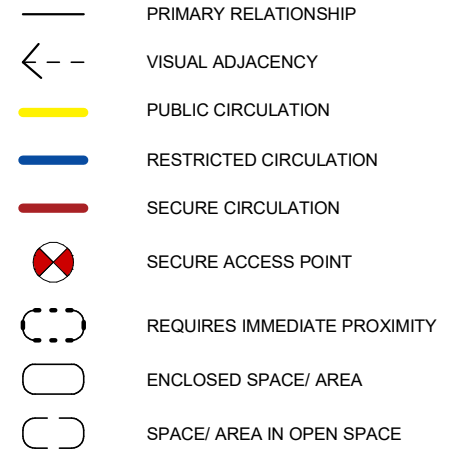
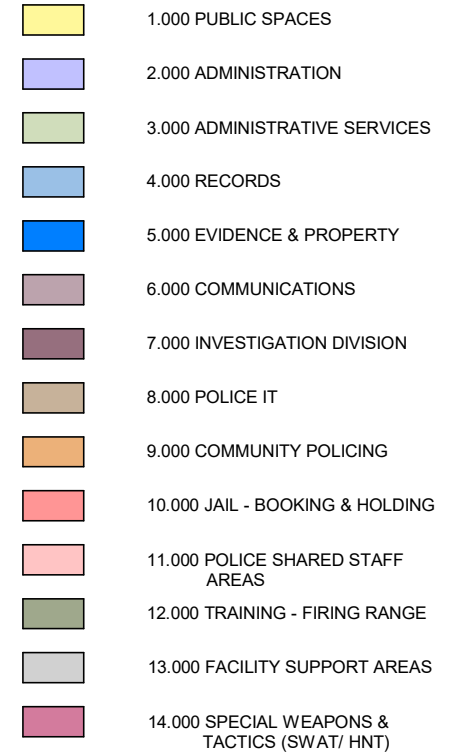

DIAGRAM LEGEND



COLOR LEGEND



3.000 ADMINISTRATIVE SERVICES

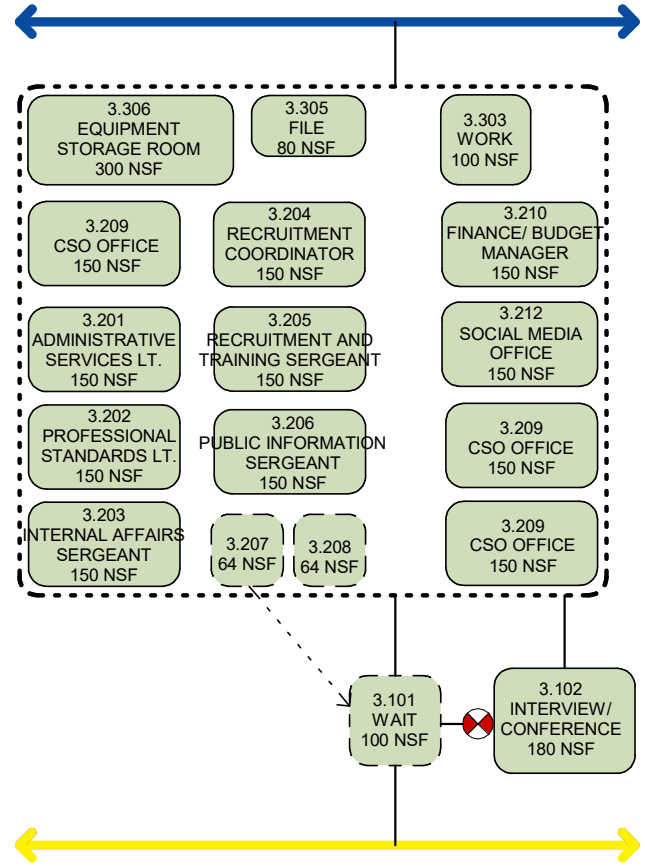

DIAGRAM LEGEND

- PRIMARY RELATIONSHIP
- ⤵ - - VISUAL ADJACENCY
- PUBLIC CIRCULATION
- RESTRICTED CIRCULATION
- SECURE CIRCULATION
- ⊗ SECURE ACCESS POINT
- ⋯ REQUIRES IMMEDIATE PROXIMITY
- ▭ ENCLOSED SPACE/ AREA
- ▭ SPACE/ AREA IN OPEN SPACE

COLOR LEGEND

- ▭ 1.000 PUBLIC SPACES
- ▭ 2.000 ADMINISTRATION
- ▭ 3.000 ADMINISTRATIVE SERVICES
- ▭ 4.000 RECORDS
- ▭ 5.000 EVIDENCE & PROPERTY
- ▭ 6.000 COMMUNICATIONS
- ▭ 7.000 INVESTIGATION DIVISION
- ▭ 8.000 POLICE IT
- ▭ 9.000 COMMUNITY POLICING
- ▭ 10.000 JAIL - BOOKING & HOLDING
- ▭ 11.000 POLICE SHARED STAFF AREAS
- ▭ 12.000 TRAINING - FIRING RANGE
- ▭ 13.000 FACILITY SUPPORT AREAS
- ▭ 14.000 SPECIAL WEAPONS & TACTICS (SWAT/ HNT)

4.000 RECORDS

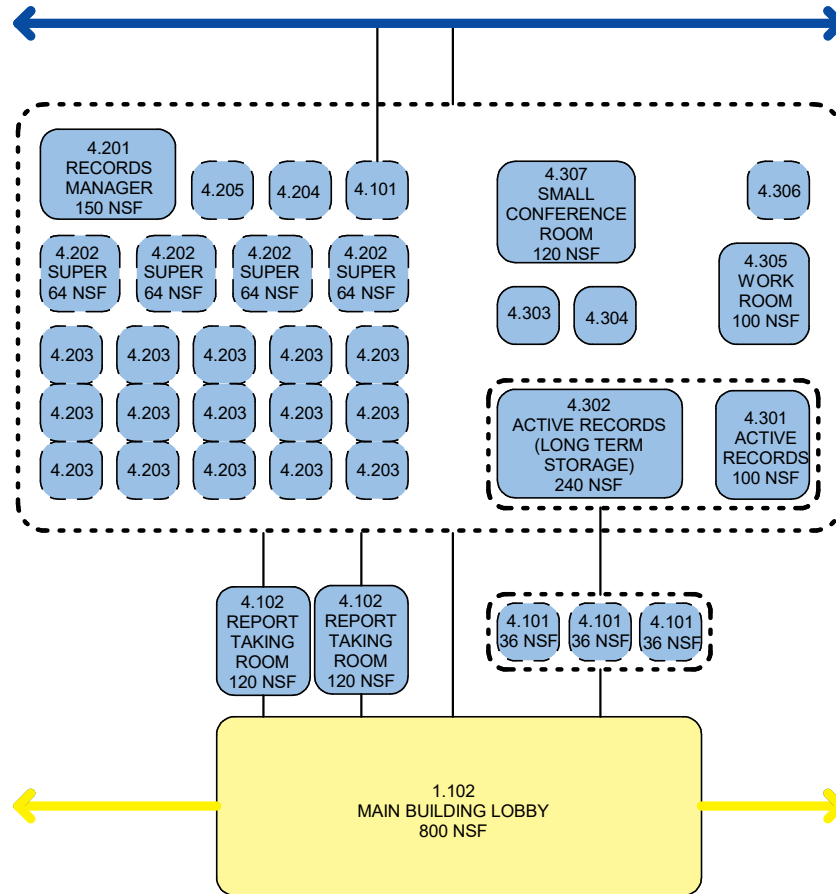

DIAGRAM LEGEND

- PRIMARY RELATIONSHIP
- ← - - VISUAL ADJACENCY
- PUBLIC CIRCULATION
- RESTRICTED CIRCULATION
- SECURE CIRCULATION
- ⊗ SECURE ACCESS POINT
- ⋯ REQUIRES IMMEDIATE PROXIMITY
- ENCLOSED SPACE/ AREA
- SPACE/ AREA IN OPEN SPACE

COLOR LEGEND

- 1.000 PUBLIC SPACES
- 2.000 ADMINISTRATION
- 3.000 ADMINISTRATIVE SERVICES
- 4.000 RECORDS
- 5.000 EVIDENCE & PROPERTY
- 6.000 COMMUNICATIONS
- 7.000 INVESTIGATION DIVISION
- 8.000 POLICE IT
- 9.000 COMMUNITY POLICING
- 10.000 JAIL - BOOKING & HOLDING
- 11.000 POLICE SHARED STAFF AREAS
- 12.000 TRAINING - FIRING RANGE
- 13.000 FACILITY SUPPORT AREAS
- 14.000 SPECIAL WEAPONS & TACTICS (SWAT/ HNT)

5.000 EVIDENCE & PROPERTY

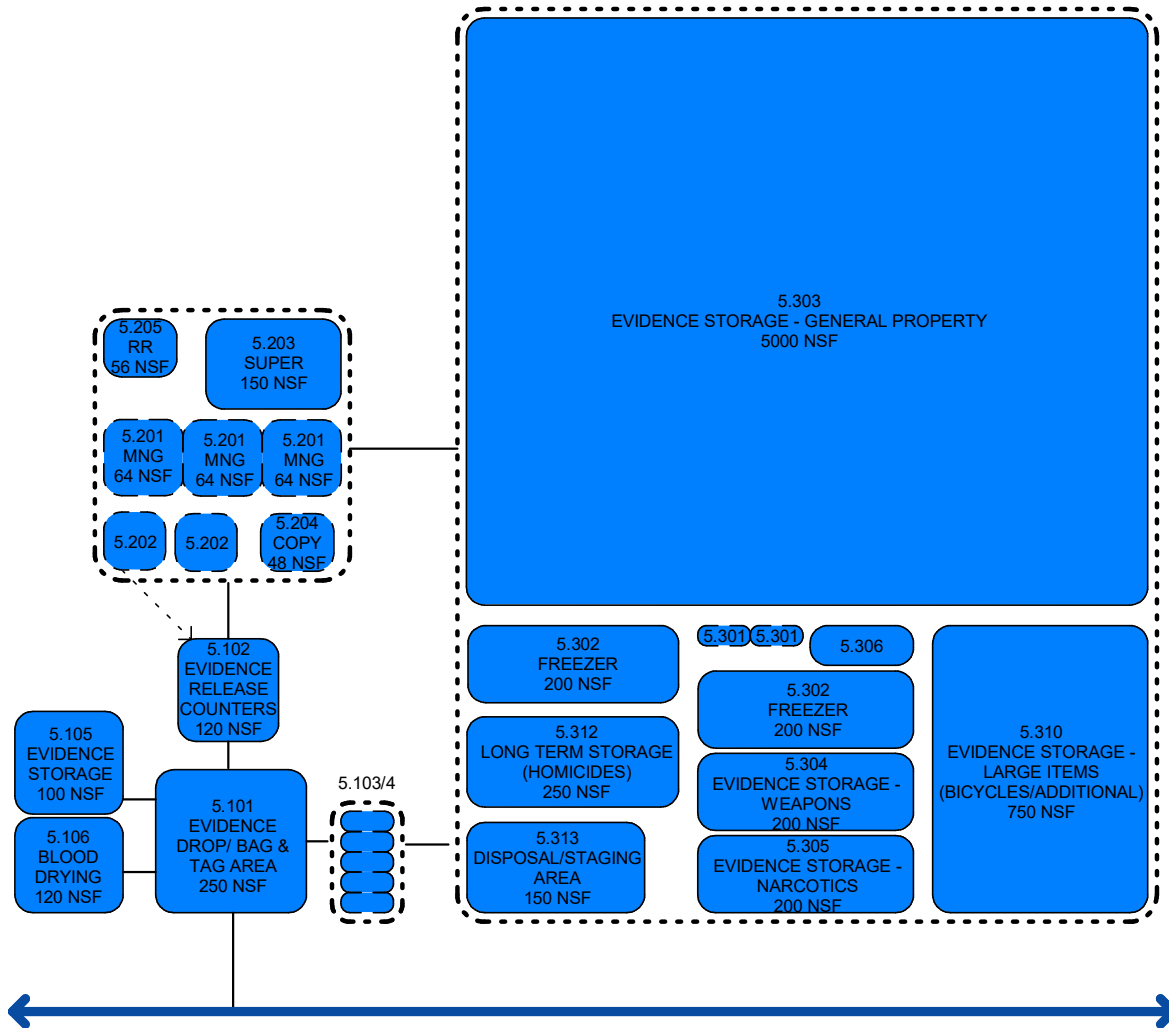

DIAGRAM LEGEND

- PRIMARY RELATIONSHIP
- ← - - VISUAL ADJACENCY
- PUBLIC CIRCULATION
- RESTRICTED CIRCULATION
- SECURE CIRCULATION
- ⊗ SECURE ACCESS POINT
- ⋯ REQUIRES IMMEDIATE PROXIMITY
- ENCLOSED SPACE/ AREA
- SPACE/ AREA IN OPEN SPACE

COLOR LEGEND

- 1.000 PUBLIC SPACES
- 2.000 ADMINISTRATION
- 3.000 ADMINISTRATIVE SERVICES
- 4.000 RECORDS
- 5.000 EVIDENCE & PROPERTY
- 6.000 COMMUNICATIONS
- 7.000 INVESTIGATION DIVISION
- 8.000 POLICE IT
- 9.000 COMMUNITY POLICING
- 10.000 JAIL - BOOKING & HOLDING
- 11.000 POLICE SHARED STAFF AREAS
- 12.000 TRAINING - FIRING RANGE
- 13.000 FACILITY SUPPORT AREAS
- 14.000 SPECIAL WEAPONS & TACTICS (SWAT/ HNT)

6.000 COMMUNICATIONS

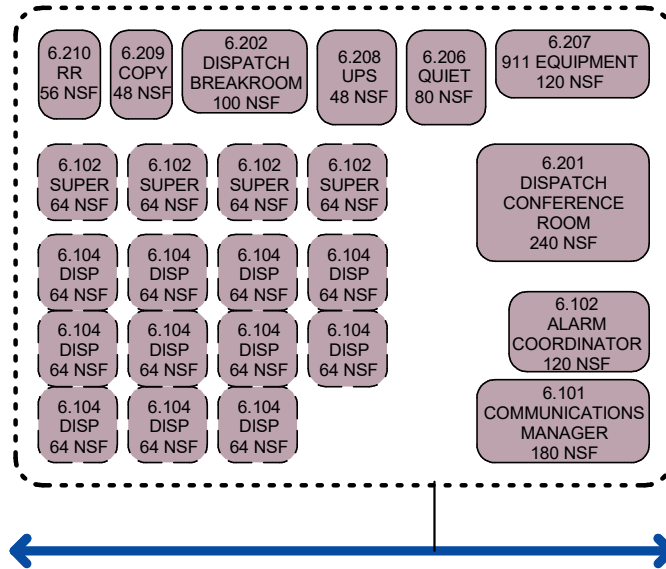

DIAGRAM LEGEND

- PRIMARY RELATIONSHIP
- VISUAL ADJACENCY
- PUBLIC CIRCULATION
- RESTRICTED CIRCULATION
- SECURE CIRCULATION
- SECURE ACCESS POINT
- REQUIRES IMMEDIATE PROXIMITY
- ENCLOSED SPACE/ AREA
- SPACE/ AREA IN OPEN SPACE

COLOR LEGEND

- 1.000 PUBLIC SPACES
- 2.000 ADMINISTRATION
- 3.000 ADMINISTRATIVE SERVICES
- 4.000 RECORDS
- 5.000 EVIDENCE & PROPERTY
- 6.000 COMMUNICATIONS
- 7.000 INVESTIGATION DIVISION
- 8.000 POLICE IT
- 9.000 COMMUNITY POLICING
- 10.000 JAIL - BOOKING & HOLDING
- 11.000 POLICE SHARED STAFF AREAS
- 12.000 TRAINING - FIRING RANGE
- 13.000 FACILITY SUPPORT AREAS
- 14.000 SPECIAL WEAPONS & TACTICS (SWAT/ HNT)

7.000 INVESTIGATIONS DIVISION

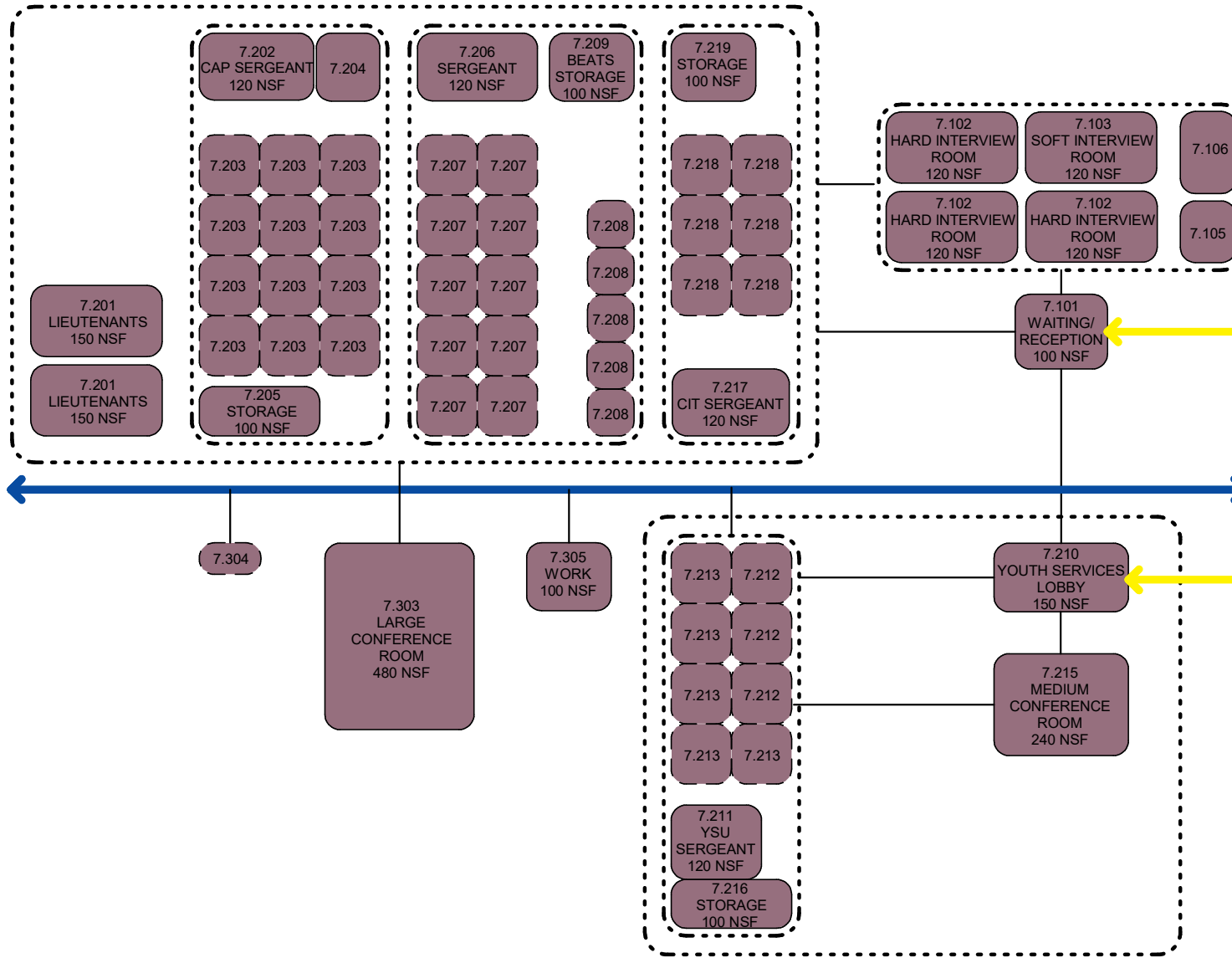

DIAGRAM LEGEND

- PRIMARY RELATIONSHIP
- ←-- VISUAL ADJACENCY
- PUBLIC CIRCULATION
- RESTRICTED CIRCULATION
- SECURE CIRCULATION
- ⊗ SECURE ACCESS POINT
- ⋯ REQUIRES IMMEDIATE PROXIMITY
- ▭ ENCLOSED SPACE/ AREA
- ▭ SPACE/ AREA IN OPEN SPACE

COLOR LEGEND

- 1.000 PUBLIC SPACES
- 2.000 ADMINISTRATION
- 3.000 ADMINISTRATIVE SERVICES
- 4.000 RECORDS
- 5.000 EVIDENCE & PROPERTY
- 6.000 COMMUNICATIONS
- 7.000 INVESTIGATION DIVISION
- 8.000 POLICE IT
- 9.000 COMMUNITY POLICING
- 10.000 JAIL - BOOKING & HOLDING
- 11.000 POLICE SHARED STAFF AREAS
- 12.000 TRAINING - FIRING RANGE
- 13.000 FACILITY SUPPORT AREAS
- 14.000 SPECIAL WEAPONS & TACTICS (SWAT/ HNT)

8.000 POLICE IT

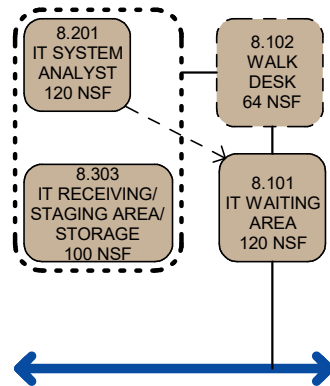

DIAGRAM LEGEND

- PRIMARY RELATIONSHIP
- ← - - VISUAL ADJACENCY
- PUBLIC CIRCULATION
- RESTRICTED CIRCULATION
- SECURE CIRCULATION
- ⊗ SECURE ACCESS POINT
- ⋯ REQUIRES IMMEDIATE PROXIMITY
- ENCLOSED SPACE/ AREA
- SPACE/ AREA IN OPEN SPACE

COLOR LEGEND

- 1.000 PUBLIC SPACES
- 2.000 ADMINISTRATION
- 3.000 ADMINISTRATIVE SERVICES
- 4.000 RECORDS
- 5.000 EVIDENCE & PROPERTY
- 6.000 COMMUNICATIONS
- 7.000 INVESTIGATION DIVISION
- 8.000 POLICE IT
- 9.000 COMMUNITY POLICING
- 10.000 JAIL - BOOKING & HOLDING
- 11.000 POLICE SHARED STAFF AREAS
- 12.000 TRAINING - FIRING RANGE
- 13.000 FACILITY SUPPORT AREAS
- 14.000 SPECIAL WEAPONS & TACTICS (SWAT/ HNT)

9.000 COMMUNITY POLICING

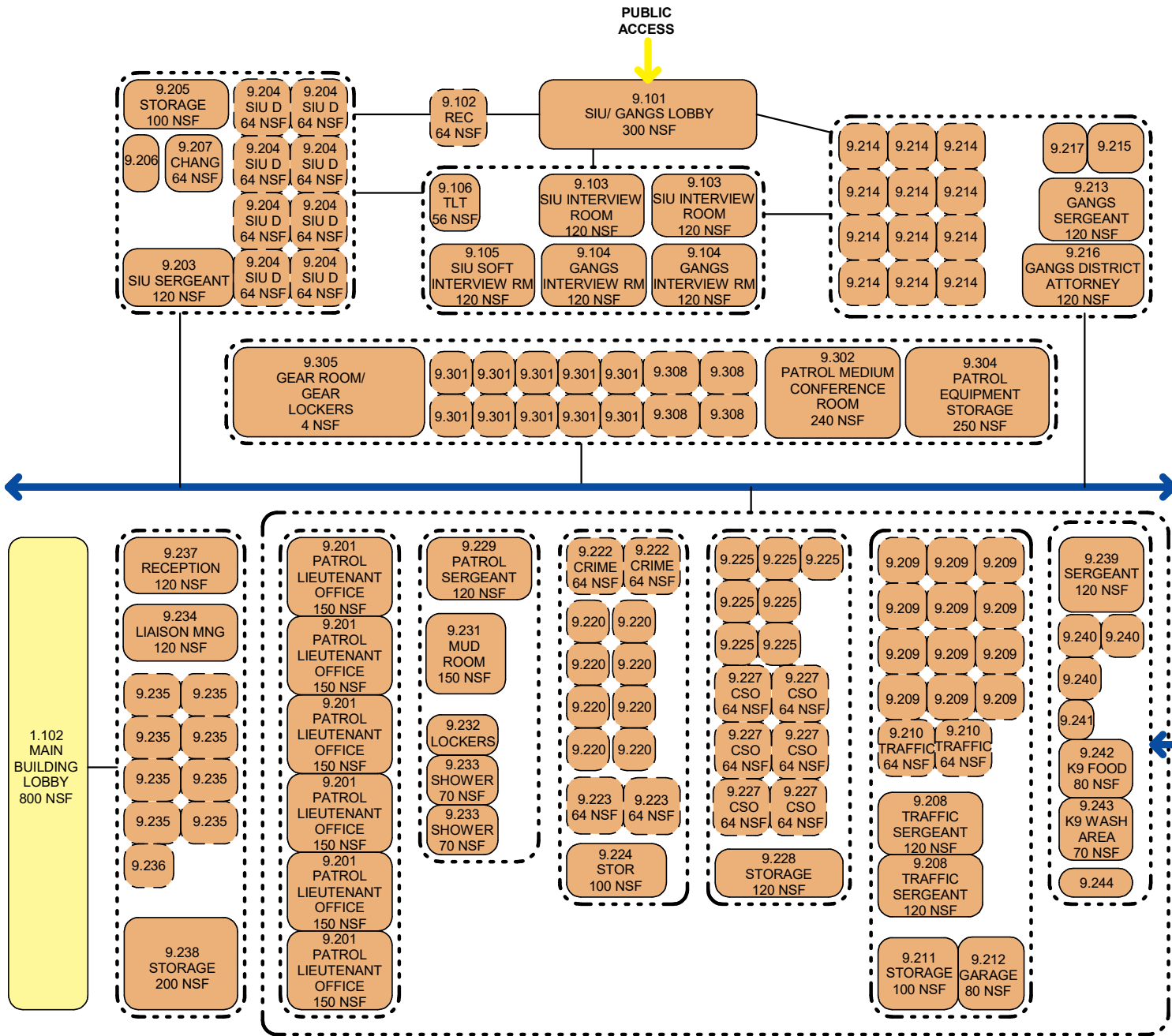

DIAGRAM LEGEND

- PRIMARY RELATIONSHIP
- VISUAL ADJACENCY
- PUBLIC CIRCULATION
- RESTRICTED CIRCULATION
- SECURE CIRCULATION
- SECURE ACCESS POINT
- REQUIRES IMMEDIATE PROXIMITY
- ENCLOSED SPACE/ AREA
- SPACE/ AREA IN OPEN SPACE

COLOR LEGEND

- 1.000 PUBLIC SPACES
- 2.000 ADMINISTRATION
- 3.000 ADMINISTRATIVE SERVICES
- 4.000 RECORDS
- 5.000 EVIDENCE & PROPERTY
- 6.000 COMMUNICATIONS
- 7.000 INVESTIGATION DIVISION
- 8.000 POLICE IT
- 9.000 COMMUNITY POLICING
- 10.000 JAIL - BOOKING & HOLDING
- 11.000 POLICE SHARED STAFF AREAS
- 12.000 TRAINING - FIRING RANGE
- 13.000 FACILITY SUPPORT AREAS
- 14.000 SPECIAL WEAPONS & TACTICS (SWAT/ HNT)

10.000 JAIL - BOOKING AND HOLDING

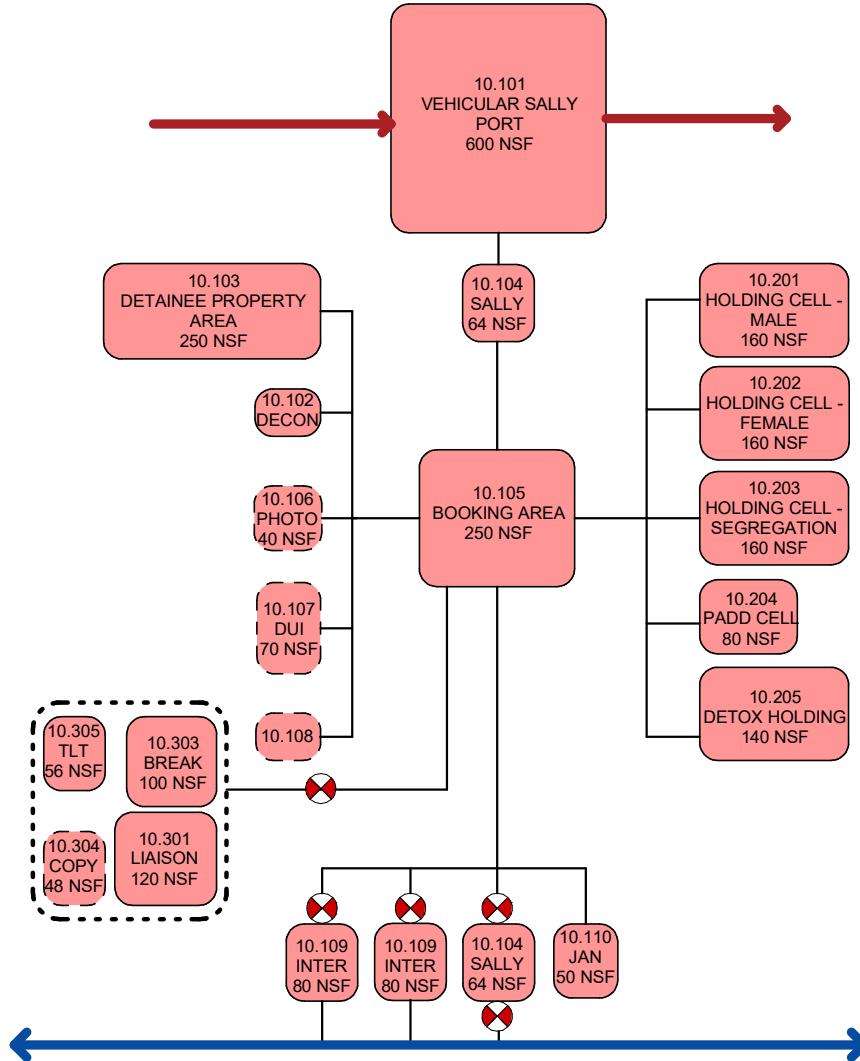

DIAGRAM LEGEND

- PRIMARY RELATIONSHIP
- ← - - VISUAL ADJACENCY
- PUBLIC CIRCULATION
- RESTRICTED CIRCULATION
- SECURE CIRCULATION
- ⊗ SECURE ACCESS POINT
- ⋯ REQUIRES IMMEDIATE PROXIMITY
- ENCLOSED SPACE/ AREA
- SPACE/ AREA IN OPEN SPACE

COLOR LEGEND

- 1.000 PUBLIC SPACES
- 2.000 ADMINISTRATION
- 3.000 ADMINISTRATIVE SERVICES
- 4.000 RECORDS
- 5.000 EVIDENCE & PROPERTY
- 6.000 COMMUNICATIONS
- 7.000 INVESTIGATION DIVISION
- 8.000 POLICE IT
- 9.000 COMMUNITY POLICING
- 10.000 JAIL - BOOKING & HOLDING
- 11.000 POLICE SHARED STAFF AREAS
- 12.000 TRAINING - FIRING RANGE
- 13.000 FACILITY SUPPORT AREAS
- 14.000 SPECIAL WEAPONS & TACTICS (SWAT/ HNT)

11.000 POLICE SHARED STAFF AREAS

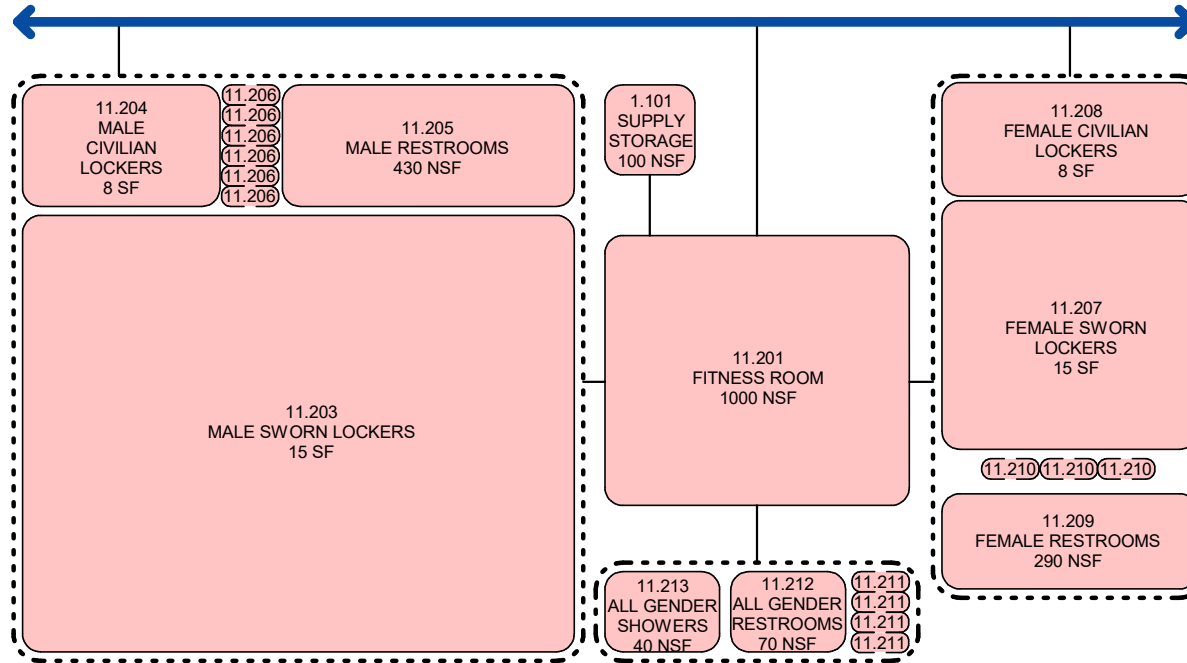

DIAGRAM LEGEND

- PRIMARY RELATIONSHIP
- ← - - VISUAL ADJACENCY
- PUBLIC CIRCULATION
- RESTRICTED CIRCULATION
- SECURE CIRCULATION
- ⊗ SECURE ACCESS POINT
- ⋯ REQUIRES IMMEDIATE PROXIMITY
- ▭ ENCLOSED SPACE/ AREA
- ▭ SPACE/ AREA IN OPEN SPACE

COLOR LEGEND

- 1.000 PUBLIC SPACES
- 2.000 ADMINISTRATION
- 3.000 ADMINISTRATIVE SERVICES
- 4.000 RECORDS
- 5.000 EVIDENCE & PROPERTY
- 6.000 COMMUNICATIONS
- 7.000 INVESTIGATION DIVISION
- 8.000 POLICE IT
- 9.000 COMMUNITY POLICING
- 10.000 JAIL - BOOKING & HOLDING
- 11.000 POLICE SHARED STAFF AREAS
- 12.000 TRAINING - FIRING RANGE
- 13.000 FACILITY SUPPORT AREAS
- 14.000 SPECIAL WEAPONS & TACTICS (SWAT/ HNT)

14.000 SPECIAL WEAPONS AND TACTICS (SWAT)/HNT

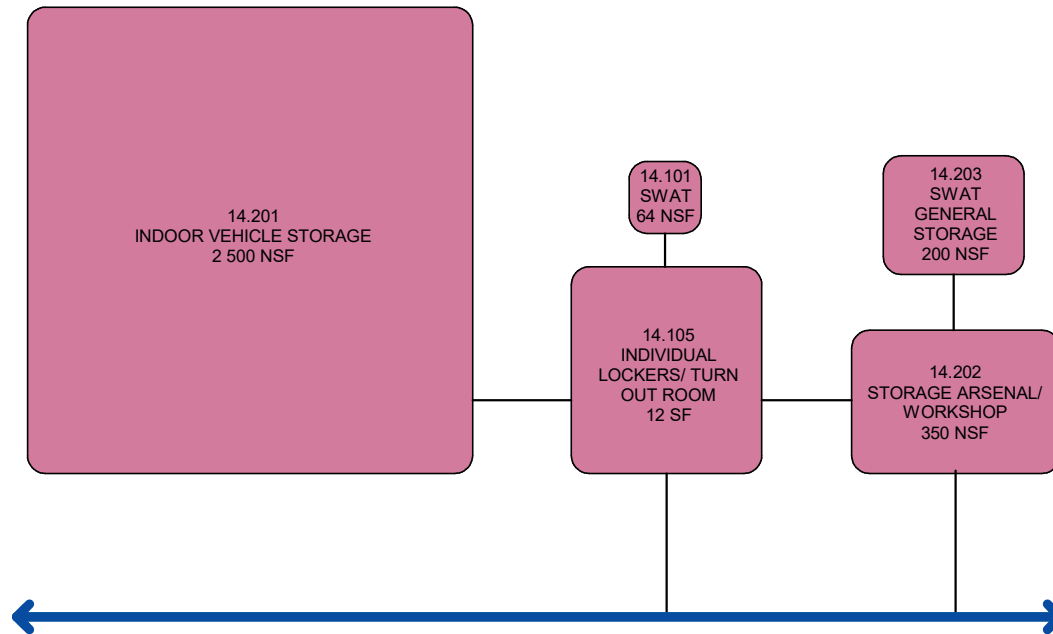

DIAGRAM LEGEND

- PRIMARY RELATIONSHIP
- ← - - VISUAL ADJACENCY
- PUBLIC CIRCULATION
- RESTRICTED CIRCULATION
- SECURE CIRCULATION
- ⊗ SECURE ACCESS POINT
- ⋯ REQUIRES IMMEDIATE PROXIMITY
- ⬭ ENCLOSED SPACE/ AREA
- ⬭ SPACE/ AREA IN OPEN SPACE

COLOR LEGEND

- 1.000 PUBLIC SPACES
- 2.000 ADMINISTRATION
- 3.000 ADMINISTRATIVE SERVICES
- 4.000 RECORDS
- 5.000 EVIDENCE & PROPERTY
- 6.000 COMMUNICATIONS
- 7.000 INVESTIGATION DIVISION
- 8.000 POLICE IT
- 9.000 COMMUNITY POLICING
- 10.000 JAIL - BOOKING & HOLDING
- 11.000 POLICE SHARED STAFF AREAS
- 12.000 TRAINING - FIRING RANGE
- 13.000 FACILITY SUPPORT AREAS
- 14.000 SPECIAL WEAPONS & TACTICS (SWAT/ HNT)